



**Technical and Test Institute
for Construction Prague**
Prosecká 811/76a
190 00 Prague
Czech Republic
eota@tzus.cz



Member of



www.eota.eu

European Technical Assessment

**ETA 21/0250
of 26/09/2023**

Technical Assessment Body issuing the ETA: Technical and Test Institute
for Construction Prague

Trade name of the construction product

ICFS CM 385 PE PRO
ICFS CM 585 PE PRO

**Product family to which the construction
product belongs**

Product area code: 33
Bonded injection type anchor for use in
cracked and uncracked concrete

Manufacturer

INDO CONSTRUCTION FASTENING
SYSTEMS (ICFS) INDO - SPARK
CONSTRUCTION SERVICES
198 E, TARARANI CHOWK, NEAR GEETA
MANDIR, KOLHAPUR 416003,
MAHARASHTRA, INDIA

Manufacturing plant

INDO CONSTRUCTION FASTENING
SYSTEMS (ICFS) INDO – SPARK plant 1

**This European Technical Assessment
contains**

22 pages including 19 Annexes which form
an integral part of this assessment.

**This European Technical Assessment is
issued in accordance with regulation
(EU) No 305/2011, on the basis of**

EAD 330499-01-0601
Bonded fasteners for use in concrete

This version replaces

ETA 21/0250 issued on 17/08/2021

Translations of this European Technical Assessment in other languages shall fully correspond to the original issued document and should be identified as such.

Communication of this European Technical Assessment, including transmission by electronic means, shall be in full (excepted the confidential Annex(es) referred to above). However, partial reproduction may be made, with the written consent of the issuing Technical Assessment Body - Technical and Test Institute for Construction Prague. Any partial reproduction has to be identified as such.

1. Technical description of the product

The ICFS CM 385 PE PRO, ICFS CM 585 PE PRO with steel elements is bonded anchor (injection type).

Steel elements can be galvanized or stainless steel threaded rods or rebars.

Steel element is placed into a drilled hole filled with injection mortar. The steel element is anchored via the bond between metal part, injection mortar and concrete. The anchor is intended to be used with various embedment depth up to 20 diameters.

The illustration and the description of the product are given in Annex A.

2. Specification of the intended use in accordance with the applicable EAD

The performances given in Section 3 are only valid if the anchor is used in compliance with the specifications and conditions given in Annex B.

The provisions made in this European Technical Assessment are based on an assumed working life of the anchor of 50 years and 100 years. The indications given on the working life cannot be interpreted as a guarantee given by the producer, but are to be regarded only as a means for choosing the products in relation to the expected economically reasonable working life of the works.

3. Performance of the product and references to the methods used for its assessment

3.1 Mechanical resistance and stability (BWR 1)

Essential characteristic	Performance
Characteristic resistance to tension load (static and quasi-static loading)	See Annex C 1 to C 5
Characteristic resistance to shear load (static and quasi-static loading)	See Annex C 6 to C 7
Displacements under short-term and long-term loading	See Annex C 8
Characteristic resistance and displacement for seismic performance categories C1 and C2	See Annex C 9 to C 11

3.2 Hygiene, health and environment (BWR 3)

No performance determined.

3.3 General aspects relating to fitness for use

Durability and serviceability are only ensured if the specifications of intended use according to Annex B 1 are kept.

4. Assessment and verification of constancy of performance (AVCP) system applied with reference to its legal base

According to the Decision 96/582/EC of the European Commission¹ the system of assessment verification of constancy of performance (see Annex V to Regulation (EU) No 305/2011) given in the following table apply.

Product	Intended use	Level or class	System
Metal anchors for use in concrete	For fixing and/or supporting to concrete, structural elements (which contributes to the stability of the works) or heavy units	-	1

¹ Official Journal of the European Communities L 254 of 08.10.1996

5. Technical details necessary for the implementation of the AVCP system, as provided in the applicable EAD

The factory production control shall be in accordance with the control plan which is a part of the technical documentation of this European Technical Assessment. The control plan is laid down in the context of the factory production control system operated by the manufacturer and deposited at Technický a zkušební ústav stavební Praha, s.p.² The results of factory production control shall be recorded and evaluated in accordance with the provisions of the control plan.

Issued in Prague on 26.09.2023

By

Ing. Jiří Studnička, Ph.D.
Head of the Technical Assessment Body

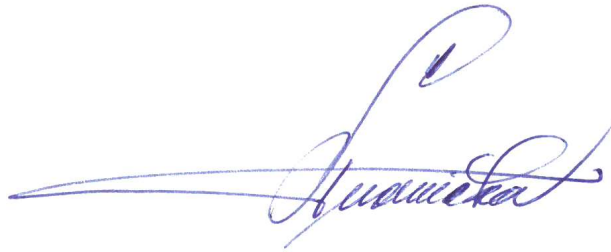

² The control plan is a confidential part of the documentation of the European Technical Assessment, but not published together with the ETA and only handed over to the approved body involved in the procedure of AVCP.

Threaded rod

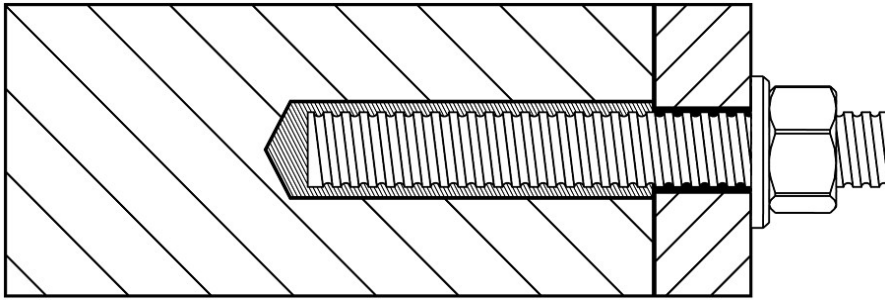

Reinforcing bar

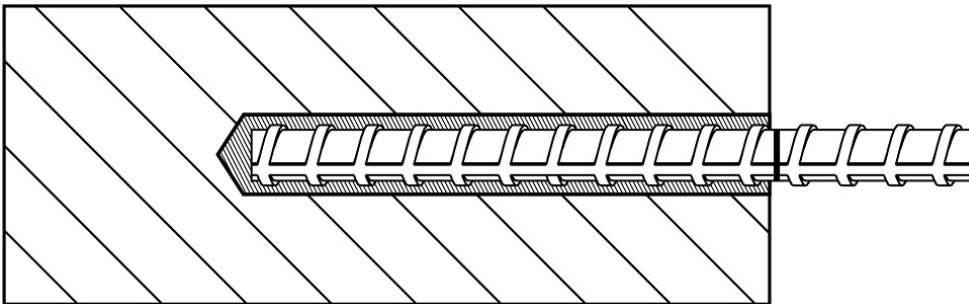

ICFS CM 385 PE PRO, ICFS CM 585 PE PRO

Product description
Installed conditions

Annex A 1

Mortar cartridges

Side by side cartridge

ICFS CM 385 PE PRO,
ICFS CM 585 PE PRO

385 ml
585 ml

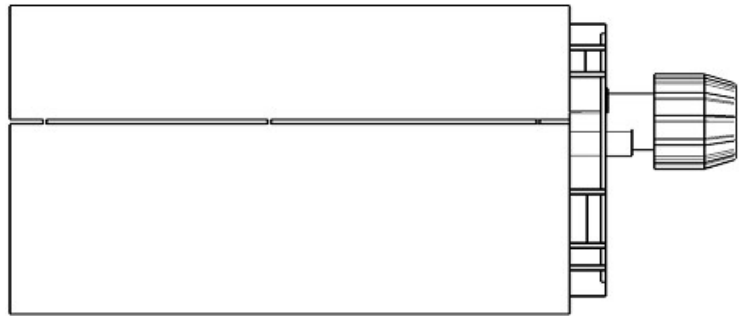

Marking of the mortar cartridges

Identifying mark of the producer, Trade name, Charge code number, Storage life, Curing and processing time

Mixing nozzle

Q mixing nozzle

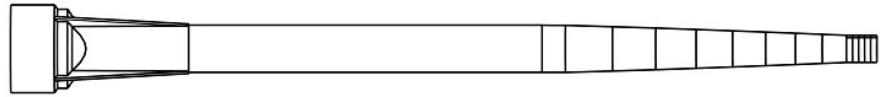

QH mixing nozzle

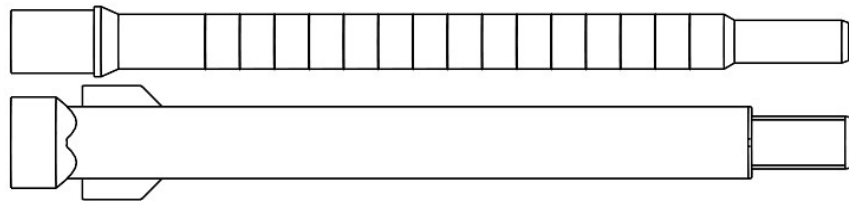

EZ-Flow mixing nozzle



ICFS CM 385 PE PRO, ICFS CM 585 PE PRO

Product description
Injection system

Annex A 2

Threaded rod M8, M10, M12, M16, M20, M24, M27, M30

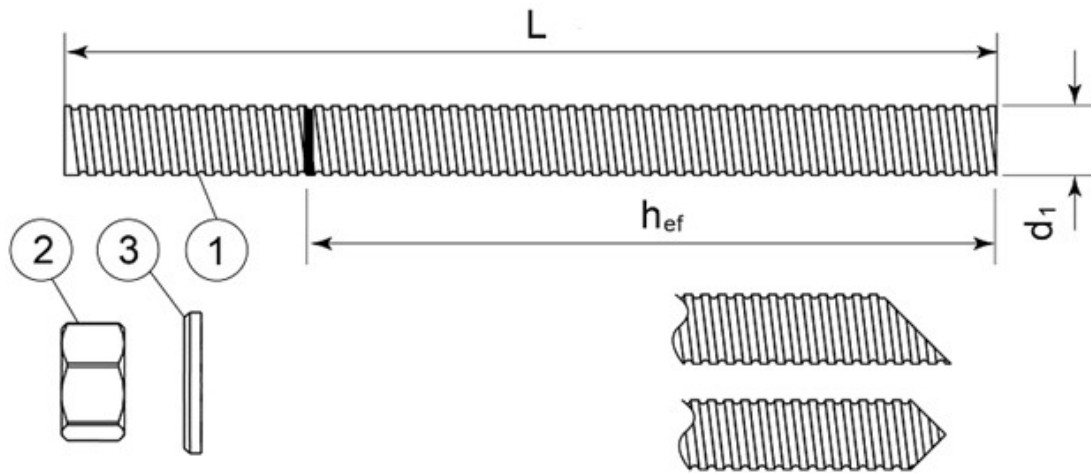

Standard commercial threaded rod with marked embedment depth

Part	Designation	Material
Steel, zinc plated $\geq 5 \mu\text{m}$ acc. to EN ISO 4042 or Steel, Hot-dip galvanized $\geq 40 \mu\text{m}$ acc. to EN ISO 1461 and EN ISO 10684 or Steel, zinc diffusion coating $\geq 15 \mu\text{m}$ acc. to EN 13811		
1	Anchor rod	Steel, EN 10087 or EN 10263 CAS 4.6, CAS 5.8, CAS 8.8, CAS 10.9* EN ISO 898-1
2	Hexagon nut EN ISO 4032	According to threaded rod, EN 20898-2
3	Washer EN ISO 887, EN ISO 7089, EN ISO 7093 or EN ISO 7094	According to threaded rod
Stainless steel		
1	Anchor rod	CAS A2-70, CAS A4-70, CAS A4-80 EN ISO 3506
2	Hexagon nut EN ISO 4032	According to threaded rod
3	Washer EN ISO 887, EN ISO 7089, EN ISO 7093 or EN ISO 7094	According to threaded rod
High corrosion resistant steel		
1	Anchor rod	CAS HCR, CAS UHCR EN 10088-1
2	Hexagon nut EN ISO 4032	According to threaded rod
3	Washer EN ISO 887, EN ISO 7089, EN ISO 7093 or EN ISO 7094	According to threaded rod

*Galvanized rod of high strength are sensitive to hydrogen induced brittle failure

ICFS CM 385 PE PRO, ICFS CM 585 PE PRO	Annex A 3
Product description Threaded rod and materials	

Rebar Ø8, Ø10, Ø12, Ø16, Ø20, Ø25, Ø32



Standard commercial reinforcing bar with marked embedment depth

Product form		Bars and de-coiled rods	
Class		B	C
Characteristic yield strength f_{yk} or $f_{0,2k}$ (MPa)		400 to 600	
Minimum value of $k = (f_t/f_y)_k$		$\geq 1,08$	$\geq 1,15$ < 1,35
Characteristic strain at maximum force ϵ_{uk} (%)		$\geq 5,0$	$\geq 7,5$
Bendability		Bend/Rebend test	
Maximum deviation from nominal mass (individual bar) (%)	Nominal bar size (mm)	$\pm 6,0$ $\pm 4,5$	
	≤ 8 > 8		
Bond: Minimum relative rib area, $f_{R,min}$	Nominal bar size (mm)	0,040 0,056	
	8 to 12 > 12		

ICFS CM 385 PE PRO, ICFS CM 585 PE PRO

Product description
Rebars and materials

Annex A 4

Specifications of intended use

Anchorage subject to:

- Static and quasi-static load
- Seismic actions category C1 (max w = 0,5 mm):
 - threaded rod size M8, M10, M12, M16, M20, M24, M27, M30
 - rebar size Ø10, Ø12, Ø16, Ø20, Ø25, Ø32
- Seismic actions category C2 (max w = 0,8 mm): threaded rod size M12, M16, M20

Base materials

- Cracked and uncracked concrete
- Reinforced or unreinforced normal weight concrete of strength class C20/25 at minimum and C50/60 at maximum according EN 206:2013.

Temperature range:

- -40°C to +70°C (max. short. term temperature +70°C and max. long term temperature +50°C)

Use conditions (Environmental conditions)

- (X1) Structures subject to dry internal conditions (zinc coated steel, stainless steel, high corrosion resistance steel).
- (X2) Structures subject to external atmospheric exposure (including industrial and marine environment) and to permanently damp internal condition, if no particular aggressive conditions exist (stainless steel A4, high corrosion resistant steel).
- (X3) Structures subject to external atmospheric exposure and to permanently damp internal condition, if other particular aggressive conditions exist (high corrosion resistant steel).

Note: *Particular aggressive conditions are e.g. permanent, alternating immersion in seawater or the splash zone of seawater, chloride atmosphere of indoor swimming pools or atmosphere with extreme chemical pollution (e.g. in desulphurization plants or road tunnels where de-icing materials are used).*

Concrete conditions:

- I1 – installation in dry or wet (water saturated) concrete and use in service in dry or wet concrete.
- I2 – installation in water-filled (not sea water) and use in service in dry or wet concrete

Design:

- The anchorages are designed in accordance with the EN 1992-4 under the responsibility of an engineer experienced in anchorages and concrete work.
- Verifiable calculation notes and drawings are prepared taking account of the loads to be anchored. The position of the anchor is indicated on the design drawings.
- Anchorages under seismic actions (cracked concrete) have to be designed in accordance with EN 1992-4.

Installation:

- Hole drilling by hammer drilling, dustless drilling or diamond core drilling mode.
- Anchor installation carried out by appropriately qualified personnel and under the supervision of the person responsible for technical matters of the site.

Installation direction:

- D3 – downward and horizontal and upwards (e.g. overhead) installation

ICFS CM 385 PE PRO, ICFS CM 585 PE PRO

Intended use
Specifications

Annex B 1

HDB – Hollow Drill Bit System

Heller Duster Expert hollow drill bit
 SDS-Plus ≤ 16mm
 SDS-Max ≥ 16mm



Cleaning steel brush



Brush extensions

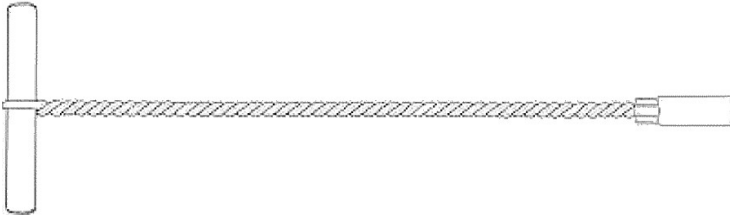

Applicator gun

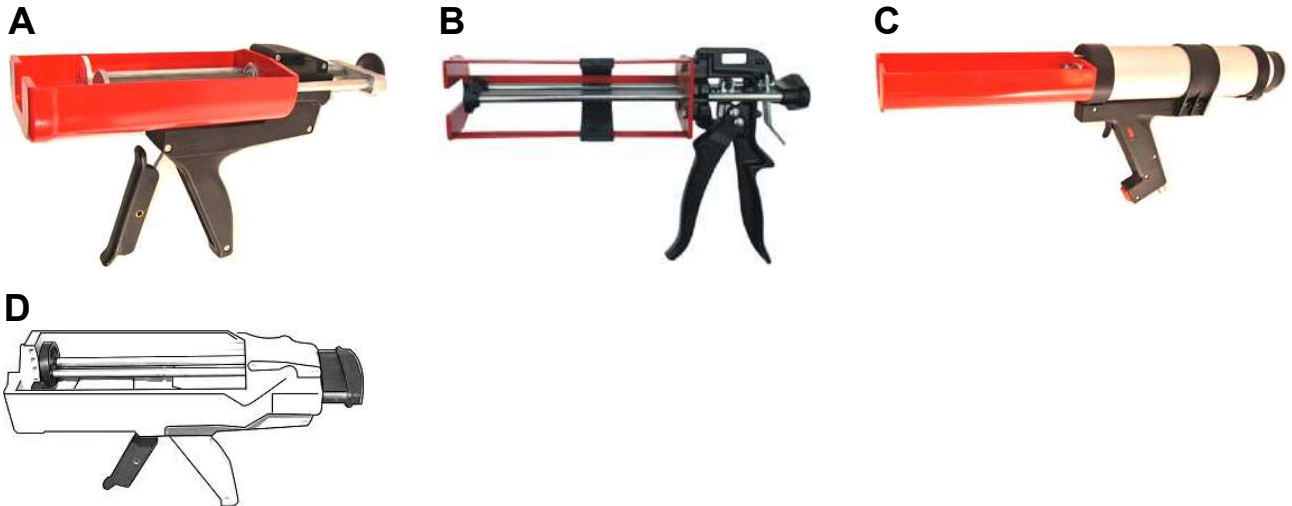

Cartridge	Applicator gun
Side by Side 385	A, B, C
Side by Side 585	D

ICFS CM 385 PE PRO, ICFS CM 585 PE PRO

Intended use
 Hollow drill bit system, Cleaning brush
 Applicator guns

Annex B 2

SOLID SUBSTRATE INSTALLATION METHOD

1. Using the SDS hammer drill (HD) in rotary hammer mode for drilling, with a carbide tipped drill bit of the appropriate size, drill the hole to the specified hole diameter and depth.



2. Select the correct air lance, insert to the bottom of the hole, and depress the trigger for 2 seconds. The compressed air must be clean and free from water and oil, with a minimum pressure of 90 psi (6 bar). Perform the blowing operation twice.



3. Select the correct size hole cleaning brush. Ensure that the brush is in good condition and of the correct diameter. Insert the brush to the bottom of the hole, using a brush extension if needed to reach the bottom. Withdraw with a twisting motion. There should be a positive interaction between the bristles of the brush and the sides of the drilled hole. Perform the brushing operation twice.



4. Repeat step 2 (blowing operation x2)

5. Repeat step 3 (brushing operation x2)

6. Repeat step 2 (blowing operation x2)

7. Select the most appropriate static mixer nozzle, checking that the mixing elements are present and t for purpose. Never modify the mixer. Attach the mixer nozzle to the cartridge. Check the dispensing tool is in good working order. Place the cartridge into the dispensing tool.

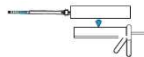

8. Extrude some resin to waste until an even coloured mixture is achieved. The cartridge is now ready for use.



9. Insert the mixing nozzle to the bottom of the hole. Extrude the resin and slowly withdraw the nozzle from the hole. Ensure no air voids are created as the nozzle is withdrawn. Inject resin until the hole is approximately ¾ full and remove the nozzle from the hole.



10. Select the steel anchor element ensuring it is free from oil or other contaminants, and mark with the required embedment depth. Insert the steel element into the hole using a back and forth twisting motion to ensure complete cover, until it reaches the bottom of the hole. Excess resin will be expelled from the hole evenly around the steel element and there shall be no gaps between the anchor element and the wall of the drilled hole.



11. Clean any excess resin from around the mouth of the hole.

12. Refer to the working and loading times within the tables to determine the appropriate cure time.



13. Position the fixture and tighten the anchor to the appropriate installation torque. Do not over-torque the anchor, as this could adversely affect its performance.



DEEP EMBEDMENT & OVERHEAD INSTALLATION METHOD

1a. Perform steps 1-8 under “solid substrate installation method”.

2a. Attach the correct diameter and length extension tube to the nozzle. Select the correct diameter resin stopper for the application, then push and screw the extension tube into the resin stopper. This is held in place with a coarse internal thread. The resin stopper is a reusable accessory.

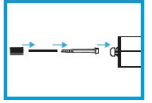

3a. Push the resin stopper and extension tube to the back of the drill hole.



4a. Ensure the extension tube is angled to allow free movement of the resin stopper as the resin is extruded.

5a. Continue from step 10 under “solid substrate installation method”.

DIAMOND CORE DRILLING

1b. Using a diamond core drill (DD) and following the manufacturer’s instructions, drill the specified diameter hole to the correct embedment depth then remove the concrete core.

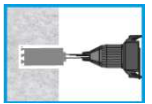

2b. Starting from the back of the hole, flush with pressurised water a minimum of two times and until there is only clean water.



3b. Select the correct size hole cleaning brush. Ensure that the brush is in good condition and of the correct diameter. Insert the brush to the bottom of the hole, using a brush extension if needed to reach the bottom. Withdraw with a twisting motion. There should be a positive interaction between the bristles of the brush and the sides of the drilled hole. Perform the brushing operation twice.



4b. Repeat step 2b (flushing operation x2).

5b. Repeat step 3b (brushing operation x2).

6a. Using the correct air lance and starting from the back of the hole and withdrawing, perform a minimum of two blowing operations and ensure that the hole is clear of debris and excess water.



7a. Continue from step 7 under “solid substrate installation method”.



DUSTLESS DRILLING

1c. Using the specified hollow drill bit (HDB) and vacuum system and following the manufacturer’s instructions, drill the specified diameter hole to the correct embedment depth. Ensure that the minimum vacuum specifications are met and that the vacuum is turned on.

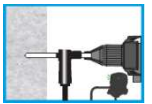

2c. The hole should be inspected to ensure the system has worked correctly. If the hole is clear of dust and debris, no further cleaning is required.



3c. Continue from step 7 under “solid substrate installation method”.

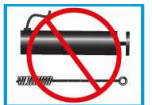

ICFS CM 385 PE PRO, ICFS CM 585 PE PRO

Intended use
Installation procedure

Annex B 3

Table B1: Installation parameters of threaded rod

Size		M8	M10	M12	M16	M20	M24	M27	M30
Nominal drill hole diameter	$\varnothing d_0$ [mm]	10	12	14	18	22	26	30	35
Cleaning brush		S11HF	S14HF	S14/15HF	S22HF	S24HF	S31HF	S31HF	S38HF
Torque moment	$\max T_{\text{fixt}}$ [Nm]	10	20	40	80	120	160	180	200
Embedment depth for $h_{\text{ef,min}}$	h_{ef} [mm]	60	60	70	80	90	96	108	120
Embedment depth for $h_{\text{ef,max}}$	h_{ef} [mm]	160	200	240	320	400	480	540	600
Depth of drill hole	h_0 [mm]	$h_{\text{ef}}+5$	$h_{\text{ef}}+5$	$h_{\text{ef}}+5$	$h_{\text{ef}}+5$	$h_{\text{ef}}+5$	$h_{\text{ef}}+5$	$h_{\text{ef}}+5$	$h_{\text{ef}}+5$
Minimum edge distance	c_{min} [mm]	40	40	40	40	50	50	50	60
Minimum spacing	s_{min} [mm]	40	40	40	40	50	50	50	60
Minimum thickness of member	h_{min} [mm]	$h_{\text{ef}} + 30 \text{ mm} \geq 100 \text{ mm}$			$h_{\text{ef}} + 2d_0$				

Table B2: Installation parameters of rebar

Size		Ø8	Ø10	Ø12	Ø16	Ø20	Ø25	Ø32
Nominal drill hole diameter	$\varnothing d_0$ [mm]	12	14	16	20	25	32	40
Cleaning brush		S12/13HF	S14/15HF	S18HF	S22HF	S27HF	S35HF	S43HF
Torque moment	$\max T_{\text{fixt}}$ [Nm]	10	20	40	80	120	180	200
Embedment depth for $h_{\text{ef,min}}$	h_{ef} [mm]	60	60	70	80	90	100	128
Embedment depth for $h_{\text{ef,max}}$	h_{ef} [mm]	160	200	240	320	400	500	640
Depth of drill hole	h_0 [mm]	$h_{\text{ef}}+5$	$h_{\text{ef}}+5$	$h_{\text{ef}}+5$	$h_{\text{ef}}+5$	$h_{\text{ef}}+5$	$h_{\text{ef}}+5$	$h_{\text{ef}}+5$
Minimum edge distance	c_{min} [mm]	40	40	40	40	50	50	70
Minimum spacing	s_{min} [mm]	40	40	40	40	50	50	70
Minimum thickness of member	h_{min} [mm]	$h_{\text{ef}} + 30 \text{ mm} \geq 100 \text{ mm}$			$h_{\text{ef}} + 2d_0$			

Table B3: Minimum curing time

Base Material Temperature [°C]	Cartridge Temperature [°C]	T Work [mins]	T Load [hrs]
+5	Minimum +10	300	24
+5°C to +10		150	
+10°C to +15	+10°C to +15	40	18
+15°C to +20	+15°C to +20	25	12
+20°C to +25	+20°C to +25	18	8
+25°C to +30	+25°C to +30	12	6
+30°C to +35	+30°C to +35	8	4
+35°C to +40	+35°C to +40	6	2
Ensure cartridge is $\geq 10^\circ\text{C}$			

T Work is typical gel time at highest base material temperature in the range.

T Load is minimum set time required until load can be applied at the lowest temperature in the range.

ICFS CM 385 PE PRO, ICFS CM 585 PE PRO

Intended use
Installation parameters
Curing time

Annex B 4

Table C1: Design method EN 1992-4
Steel failure - Characteristic values of resistance to tension load of threaded rod

Steel failure – Characteristic resistance										
Size			M8	M10	M12	M16	M20	M24	M27	M30
CAS 4.6	$N_{Rk,s}$	[kN]	15	23	34	63	98	141	184	224
Partial safety factor	γ_{Ms}	[-]	2,00							
CAS 5.8	$N_{Rk,s}$	[kN]	18	29	42	79	123	177	230	281
Partial safety factor	γ_{Ms}	[-]	1,50							
CAS 8.8	$N_{Rk,s}$	[kN]	29	46	67	126	196	282	367	449
Partial safety factor	γ_{Ms}	[-]	1,50							
CAS 10.9	$N_{Rk,s}$	[kN]	37	58	84	157	245	353	459	561
Partial safety factor	γ_{Ms}	[-]	1,33							
CAS A2-70, CAS A4-70	$N_{Rk,s}$	[kN]	26	41	59	110	172	247	321	393
Partial safety factor	γ_{Ms}	[-]	1,87							
CAS A4-80	$N_{Rk,s}$	[kN]	29	46	67	126	196	282	367	449
Partial safety factor	γ_{Ms}	[-]	1,60							
CAS HCR	$N_{Rk,s}$	[kN]	26	41	59	110	172	247	321	393
Partial safety factor	γ_{Ms}	[-]	1,50							
CAS UHCR	$N_{Rk,s}$	[kN]	26	41	59	110	172	247	321	393
Partial safety factor	γ_{Ms}	[-]	1,87							

Table C2: Design method EN 1992-4
Steel failure - Characteristic values of resistance to tension load of rebar

Steel failure – Characteristic resistance									
Size			Ø8	Ø10	Ø12	Ø16	Ø20	Ø25	Ø32
Rebar BSt 500 S	$N_{Rk,s}$	[kN]	28	43	62	111	173	270	442
Partial safety factor	γ_{Ms}	[-]	1,4						

ICFS CM 385 PE PRO, ICFS CM 585 PE PRO

Performances
Steel failure characteristic resistance

Annex C 1

Table C3: Design method EN 1992-4

Characteristic values of resistance to tension load of threaded rod

Combined pullout and concrete cone failure in concrete C20/25									
Hammer drilling, Dustless drilling									
Size	M8	M10	M12	M16	M20	M24	M27	M30	
Characteristic bond resistance in uncracked concrete for a working life of 50 years and 100 years									
Dry and wet concrete, Flooded hole	$\tau_{Rk,ucr}$ [N/mm ²]	14,0	13,0	13,0	12,0	12,0	11,0	10,0	9,0
Installation safety factor									
Dry, wet concrete	γ_{inst} [-]				1,0				
Hammer drilling – Flooded hole	γ_{inst} [-]				1,0				
Dustless drilling – Flooded hole	γ_{inst} [-]				1,2				
Characteristic bond resistance in cracked concrete for a working life of 50 years and 100 years									
Dry and wet concrete, Flooded hole	$\tau_{Rk,cr}$ [N/mm ²]	8,0	8,0	7,5	7,5	7,0	7,0	5,0	5,0
Installation safety factor									
Dry, wet concrete	γ_{inst} [-]				1,0				
Hammer drilling – Flooded hole	γ_{inst} [-]				1,0				
Dustless drilling – Flooded hole	γ_{inst} [-]				1,2				
Factor for influence of sustained load for a working life 50 years	ψ^0_{sus} [-]				0,74				
Factor for concrete	C25/30	ψ_c [-]				1,02			
	C30/37					1,04			
	C35/45					1,06			
	C40/50					1,07			
	C45/55					1,08			
C50/60				1,09					

Concrete cone failure			
Factor for concrete cone failure for uncracked concrete	$k_{ucr,N}$	[-]	11
Factor for concrete cone failure for cracked concrete	$k_{cr,N}$		7,7
Edge distance	$c_{cr,N}$ [mm]		1,5 h_{ef}

Splitting failure									
Size	M8	M10	M12	M16	M20	M24	M27	M30	
Edge distance	$c_{cr,sp}$ [mm]								2 h_{ef}
Spacing	$s_{cr,sp}$ [mm]								2 $c_{cr,sp}$

ICFS CM 385 PE PRO, ICFS CM 585 PE PRO**Performances**

Hammer drilling, Dustless drilling

Characteristic resistance for tension loads - threaded rod

Annex C 2

Table C4: Design method EN 1992-4
Characteristic values of resistance to tension load of rebar

Combined pullout and concrete cone failure in concrete C20/25									
Hammer drilling, Dustless drilling									
Size			Ø8	Ø10	Ø12	Ø16	Ø20	Ø25	Ø32
Characteristic bond resistance in uncracked concrete for a working life of 50 years and 100 years									
Dry and wet concrete, Flooded hole	$\tau_{Rk,ucr}$	[N/mm ²]	12,0	12,0	12,0	11,0	11,0	11,0	7,0
Installation safety factor									
Hammer drilling - Dry, wet concrete	γ_{inst}	[-]	1,0						
Dustless drilling - Dry, wet concrete	γ_{inst}	[-]	1,2						
Flooded hole	γ_{inst}	[-]	1,2						
Characteristic bond resistance in cracked concrete for a working life of 50 years and 100 years									
Dry and wet concrete, Flooded hole	$\tau_{Rk,cr}$	[N/mm ²]	7,0	10,0	9,0	9,0	8,0	8,0	5,0
Installation safety factor									
Hammer drilling - Dry, wet concrete	γ_{inst}	[-]	1,0						
Dustless drilling - Dry, wet concrete	γ_{inst}	[-]	1,2						
Flooded hole	γ_{inst}	[-]	1,2						
Factor for influence of sustained load for a working life 50 years	ψ^0_{sus}	[-]	0,74						
Factor for concrete	C25/30	ψ_c	[-]	1,02					
	C30/37			1,04					
	C35/45			1,06					
	C40/50			1,07					
	C45/55			1,08					
	C50/60			1,09					

Concrete cone failure			
Factor for concrete cone failure for uncracked concrete	$k_{ucr,N}$	[-]	11
Factor for concrete cone failure for cracked concrete	$k_{cr,N}$		7,7
Edge distance	$c_{cr,N}$	[mm]	1,5 h_{ef}

Splitting failure									
Size			Ø8	Ø10	Ø12	Ø16	Ø20	Ø25	Ø32
Edge distance	$c_{cr,sp}$	[mm]	2 h_{ef}						
Spacing	$s_{cr,sp}$	[mm]	2 $c_{cr,sp}$						

ICFS CM 385 PE PRO, ICFS CM 585 PE PRO

Performances

Hammer drilling, Dustless drilling
Characteristic resistance for tension loads - rebar

Annex C 3

Table C5: Design method EN 1992-4

Characteristic values of resistance to tension load of threaded rod

Combined pullout and concrete cone failure in concrete C20/25									
Diamond core drilling									
Size	M8	M10	M12	M16	M20	M24	M27	M30	
Characteristic bond resistance in uncracked concrete for a working life of 50 years and 100 years									
Dry and wet concrete, Flooded hole	$\tau_{Rk,ucr}$ [N/mm ²]	14,0	13,0	13,0	12,0	12,0	10,0	10,0	9,0
Installation safety factor									
Dry, wet concrete	γ_{inst}	[-]		1,0					
Flooded hole	γ_{inst}	[-]		1,2					
Characteristic bond resistance in cracked concrete for a working life of 50 years									
Dry and wet concrete, Flooded hole	$\tau_{Rk,cr}$ [N/mm ²]	8,0	8,0	7,5	7,5	7,0	7,0	5,0	5,0
Characteristic bond resistance in cracked concrete for a working life of 100 years									
Dry and wet concrete, Flooded hole	$\tau_{Rk,cr}$ [N/mm ²]	6,5	7,0	6,5	6,0	6,0	6,0	5,0	4,5
Installation safety factor									
Dry, wet concrete	γ_{inst}	[-]		1,0					
Flooded hole	γ_{inst}	[-]		1,2					
Factor for influence of sustained load for a working life 50 years	ψ^{0}_{sus}	[-]		0,76					
Factor for concrete	C25/30	ψ_c	[-]	1,02					
	C30/37			1,04					
	C35/45			1,06					
	C40/50			1,07					
	C45/55			1,08					
	C50/60	1,09							

Concrete cone failure			
Factor for concrete cone failure for uncracked concrete	$k_{ucr,N}$	[-]	11
Factor for concrete cone failure for cracked concrete	$k_{cr,N}$		7,7
Edge distance	$c_{cr,N}$	[mm]	1,5 h_{ef}

Splitting failure									
Size	M8	M10	M12	M16	M20	M24	M27	M30	
Edge distance	$c_{cr,sp}$	[mm]		2 h_{ef}					
Spacing	$s_{cr,sp}$	[mm]		2 $c_{cr,sp}$					

ICFS CM 385 PE PRO, ICFS CM 585 PE PRO

Performances

Diamond core drilling
Characteristic resistance for tension loads - threaded rod

Annex C 4

Table C6: Design method EN 1992-4
Characteristic values of resistance to tension load of rebar

Combined pullout and concrete cone failure in concrete C20/25									
Diamond core drilling									
Size			Ø8	Ø10	Ø12	Ø16	Ø20	Ø25	Ø32
Characteristic bond resistance in uncracked concrete for a working life of 50 years and 100 years									
Dry and wet concrete, Flooded hole	$\tau_{Rk,ucr}$	[N/mm ²]	12,0	11,0	12,0	11,0	10,0	10,0	7,0
Installation safety factor									
Dry, wet concrete	γ_{inst}	[-]	1,0						
Flooded hole	γ_{inst}	[-]	1,2						
Characteristic bond resistance in cracked concrete for a working life of 50 years									
Dry and wet concrete, Flooded hole	$\tau_{Rk,cr}$	[N/mm ²]	7,0	7,0	7,0	7,0	6,0	6,0	4,5
Characteristic bond resistance in cracked concrete for a working life of 100 years									
Dry and wet concrete, Flooded hole	$\tau_{Rk,cr}$	[N/mm ²]	6,0	7,0	7,0	7,0	6,0	6,0	4,5
Installation safety factor									
Dry, wet concrete	γ_{inst}	[-]	1,0						
Flooded hole	γ_{inst}	[-]	1,2						
Factor for influence of sustained load for a working life 50 years	ψ_{sus}^0	[-]	0,76						
Factor for concrete	C25/30	ψ_c	[-]	1,02					
	C30/37			1,04					
	C35/45			1,06					
	C40/50			1,07					
	C45/55			1,08					
	C50/60			1,09					

Concrete cone failure			
Factor for concrete cone failure for uncracked concrete	$k_{ucr,N}$	[-]	11
Factor for concrete cone failure for cracked concrete	$k_{cr,N}$		7,7
Edge distance	$c_{cr,N}$	[mm]	1,5 h_{ef}

Splitting failure									
Size			Ø8	Ø10	Ø12	Ø16	Ø20	Ø25	Ø32
Edge distance	$c_{cr,sp}$	[mm]	2 h_{ef}						
Spacing	$s_{cr,sp}$	[mm]	2 $c_{cr,sp}$						

ICFS CM 385 PE PRO, ICFS CM 585 PE PRO	Annex C 5
Performances	
Diamond core drilling Characteristic resistance for tension loads - rebar	

Table C7: Design method EN 1992-4
Characteristic values of resistance to shear load of threaded rod

Steel failure without lever arm											
Size			M8	M10	M12	M16	M20	M24	M27	M30	
CAS 4.6	$V_{Rk,s}$	[kN]	7	12	17	31	49	71	92	112	
Partial safety factor	γ_{Ms}	[-]	1,67								
CAS 5.8	$V_{Rk,s}$	[kN]	9	15	21	39	61	88	115	140	
Partial safety factor	γ_{Ms}	[-]	1,25								
CAS 8.8	$V_{Rk,s}$	[kN]	15	23	34	63	98	141	184	224	
Partial safety factor	γ_{Ms}	[-]	1,25								
CAS 10.9	$V_{Rk,s}$	[kN]	18	29	42	79	123	177	230	281	
Partial safety factor	γ_{Ms}	[-]	1,5								
CAS A2-70, CAS A4-70	$V_{Rk,s}$	[kN]	13	20	30	55	86	124	161	196	
Partial safety factor	γ_{Ms}	[-]	1,56								
CAS A4-80	$V_{Rk,s}$	[kN]	15	23	34	63	98	141	184	224	
Partial safety factor	γ_{Ms}	[-]	1,33								
CAS HCR	$V_{Rk,s}$	[kN]	13	20	30	55	86	124	161	196	
Partial safety factor	γ_{Ms}	[-]	1,25								
CAS UHCR	$V_{Rk,s}$	[kN]	13	20	30	55	86	124	161	196	
Partial safety factor	γ_{Ms}	[-]	1,56								
Characteristic resistance of group of fasteners											
Ductility factor $k_7 = 1,0$ for steel with rupture elongation $A_5 > 8\%$											

Steel failure with lever arm											
Size			M8	M10	M12	M16	M20	M24	M27	M30	
CAS 4.6	$M^o_{Rk,s}$	[N.m]	15	30	52	133	260	449	666	900	
Partial safety factor	γ_{Ms}	[-]	1,67								
CAS 5.8	$M^o_{Rk,s}$	[N.m]	19	37	66	166	325	561	832	1125	
Partial safety factor	γ_{Ms}	[-]	1,25								
CAS 8.8	$M^o_{Rk,s}$	[N.m]	30	60	105	266	519	898	1332	1799	
Partial safety factor	γ_{Ms}	[-]	1,25								
CAS 10.9	$M^o_{Rk,s}$	[N.m]	37	75	131	333	649	1123	1664	2249	
Partial safety factor	γ_{Ms}	[-]	1,50								
CAS A2-70, CAS A4-70	$M^o_{Rk,s}$	[N.m]	26	52	92	233	454	786	1165	1574	
Partial safety factor	γ_{Ms}	[-]	1,56								
CAS A4-80	$M^o_{Rk,s}$	[N.m]	30	60	105	266	519	898	1332	1799	
Partial safety factor	γ_{Ms}	[-]	1,33								
CAS HCR	$M^o_{Rk,s}$	[N.m]	26	52	92	233	454	786	1165	1574	
Partial safety factor	γ_{Ms}	[-]	1,25								
CAS UHCR	$M^o_{Rk,s}$	[N.m]	26	52	92	233	454	786	1165	1574	
Partial safety factor	γ_{Ms}	[-]	1,56								
Concrete pryout failure											
Factor for resistance to pry-out failure	k_8	[-]	2								

Concrete edge failure											
Size			M8	M10	M12	M16	M20	M24	M27	M30	
Outside diameter of fastener	d_{nom}	[mm]	8	10	12	16	20	24	27	30	
Effective length of fastener	l_f	[mm]	min (h_{ef} , 8 d_{nom})								

ICFS CM 385 PE PRO, ICFS CM 585 PE PRO

Performances

Design according to EN 1992-4
Characteristic resistance for shear loads - threaded rod

Annex C 6

Table C8: Design method EN 1992-4
Characteristic values of resistance to shear load of rebar

Steel failure without lever arm								
Size		Ø8	Ø10	Ø12	Ø16	Ø20	Ø25	Ø32
Rebar BSt 500 S	$V_{Rk,s}$ [kN]	14	22	31	55	86	135	221
Partial safety factor	γ_{Ms} [-]	1,5						
Characteristic resistance of group of fasteners								
Ductility factor $k_7 = 1,0$ for steel with rupture elongation $A_5 > 8\%$								
Steel failure with lever arm								
Size		Ø8	Ø10	Ø12	Ø16	Ø20	Ø25	Ø32
Rebar BSt 500 S	$M^o_{Rk,s}$ [N.m]	33	65	112	265	518	1013	2122
Partial safety factor	γ_{Ms} [-]	1,5						
Concrete pryout failure								
Factor for resistance to pry-out failure	k_8 [-]	2						
Concrete edge failure								
Size		Ø8	Ø10	Ø12	Ø16	Ø20	Ø25	Ø32
Outside diameter of fastener	d_{nom} [mm]	8	10	12	16	20	25	32
Effective length of fastener	l_f [mm]	min ($h_{ef}, 8 d_{nom}$)						

ICFS CM 385 PE PRO, ICFS CM 585 PE PRO

Performances
Design according to EN 1992-4
Characteristic resistance for shear loads - rebar

Annex C 7

Table C9: Displacement of threaded rod under tension and shear load
Hammer drilling, dustless drilling

Size	M8	M10	M12	M16	M20	M24	M27	M30
Tension load								
Uncracked concrete								
δ_{N0} [mm/kN]	0,03	0,02	0,02	0,02	0,01	0,01	0,01	0,01
$\delta_{N\infty}$ [mm/kN]	0,05	0,04	0,03	0,03	0,02	0,02	0,01	0,01
Cracked concrete								
δ_{N0} [mm/kN]	0,05	0,04	0,03	0,03	0,02	0,02	0,02	0,02
$\delta_{N\infty}$ [mm/kN]	0,35	0,21	0,14	0,12	0,08	0,07	0,07	0,07
Shear load								
δ_{V0} [mm/kN]	0,71	0,45	0,31	0,17	0,11	0,07	0,06	0,05
$\delta_{V\infty}$ [mm/kN]	1,06	0,67	0,46	0,25	0,16	0,11	0,08	0,07

Table C10: Displacement of threaded rod under tension and shear load
Diamond core drilling

Size	M8	M10	M12	M16	M20	M24	M27	M30
Tension load								
Uncracked concrete								
δ_{N0} [mm/kN]	0,01	0,01	0,02	0,02	0,02	0,02	0,01	0,02
$\delta_{N\infty}$ [mm/kN]	0,09	0,07	0,05	0,04	0,03	0,02	0,02	0,02
Cracked concrete								
δ_{N0} [mm/kN]	0,03	0,04	0,04	0,04	0,03	0,03	0,04	0,04
$\delta_{N\infty}$ [mm/kN]	0,33	0,28	0,20	0,14	0,12	0,09	0,09	0,08
Shear load								
δ_{V0} [mm/kN]	0,71	0,45	0,31	0,17	0,11	0,07	0,06	0,05
$\delta_{V\infty}$ [mm/kN]	1,06	0,67	0,46	0,25	0,16	0,11	0,08	0,07

Table C11: Displacement of rebar under tension and shear load
Hammer drilling, dustless drilling

Size	Ø8	Ø10	Ø12	Ø16	Ø20	Ø25	Ø32
Tension load							
Uncracked concrete							
δ_{N0} [mm/kN]	0,04	0,03	0,02	0,01	0,01	0,01	0,01
$\delta_{N\infty}$ [mm/kN]	0,08	0,05	0,04	0,02	0,02	0,01	0,01
Cracked concrete							
δ_{N0} [mm/kN]	0,05	0,04	0,03	0,03	0,02	0,02	0,02
$\delta_{N\infty}$ [mm/kN]	0,35	0,21	0,17	0,11	0,08	0,07	0,06
Shear load							
δ_{V0} [mm/kN]	0,38	0,24	0,17	0,10	0,06	0,04	0,02
$\delta_{V\infty}$ [mm/kN]	0,56	0,36	0,25	0,14	0,09	0,06	0,04

Table C12: Displacement of rebar under tension and shear load
Diamond drilling

Size	Ø8	Ø10	Ø12	Ø16	Ø20	Ø25	Ø32
Tension load							
Uncracked concrete							
δ_{N0} [mm/kN]	0,02	0,02	0,02	0,01	0,01	0,01	0,01
$\delta_{N\infty}$ [mm/kN]	0,09	0,06	0,04	0,03	0,02	0,01	0,01
Cracked concrete							
δ_{N0} [mm/kN]	0,04	0,03	0,03	0,02	0,02	0,01	0,01
$\delta_{N\infty}$ [mm/kN]	0,39	0,26	0,18	0,10	0,07	0,04	0,03
Shear load							
δ_{V0} [mm/kN]	0,38	0,24	0,17	0,10	0,06	0,04	0,02
$\delta_{V\infty}$ [mm/kN]	0,56	0,36	0,25	0,14	0,09	0,06	0,04

ICFS CM 385 PE PRO, ICFS CM 585 PE PRO

Performances
Displacements

Annex C 8

Table C13: Seismic performance category C1 of threaded rod - Hammer drilling, Dustless drilling

Size			M8	M10	M12	M16	M20	M24	M27	M30
Tension load										
Steel failure										
Characteristic resistance CAS 4.6	$N_{Rk,s,C1}$	[kN]	15	23	34	63	98	141	184	224
Partial safety factor	γ_{Ms}	[-]	2,00							
Characteristic resistance CAS 5.8	$N_{Rk,s,C1}$	[kN]	18	29	42	79	123	177	230	281
Partial safety factor	γ_{Ms}	[-]	1,50							
Characteristic resistance CAS 8.8	$N_{Rk,s,C1}$	[kN]	29	46	67	126	196	282	367	449
Partial safety factor	γ_{Ms}	[-]	1,50							
Characteristic resistance CAS 10.9	$N_{Rk,s,C1}$	[kN]	37	58	84	157	245	353	459	561
Partial safety factor	γ_{Ms}	[-]	1,33							
Characteristic resistance CAS A2-70, CAS A4-70	$N_{Rk,s,C1}$	[kN]	26	41	59	110	172	247	321	393
Partial safety factor	γ_{Ms}	[-]	1,87							
Characteristic resistance CAS A4-80	$N_{Rk,s,C1}$	[kN]	29	46	67	126	196	282	367	449
Partial safety factor	γ_{Ms}	[-]	1,60							
Characteristic resistance CAS HCR	$N_{Rk,s,C1}$	[kN]	26	41	59	110	172	247	321	393
Partial safety factor	γ_{Ms}	[-]	1,50							
Characteristic resistance CAS UHCR	$N_{Rk,s,C1}$	[kN]	26	41	59	110	172	247	321	393
Partial safety factor	γ_{Ms}	[-]	1,87							
Combined pullout and concrete cone failure in concrete C20/25 for a working life of 50 years and 100 years										
Characteristic bond resistance										
Dry and wet concrete, Flooded hole	$\tau_{Rk,p,C1}$	[N/mm ²]	8,0	8,0	7,5	7,5	7,0	7,0	5,0	4,5
Installation safety factor										
Dry, wet concrete	γ_{inst}	[-]	1,0							
Hammer drilling – Flooded hole	γ_{inst}	[-]	1,0							
Dustless drilling – Flooded hole	γ_{inst}	[-]	1,2							
Shear load										
Steel failure without lever arm										
Characteristic resistance CAS 4.6	$V_{Rk,s,C1}$	[kN]	5	9	13	20	32	28	37	45
Partial safety factor	γ_{Ms}	[-]	1,67							
Characteristic resistance CAS 5.8	$V_{Rk,s,C1}$	[kN]	7	11	16	26	40	35	46	56
Partial safety factor	γ_{Ms}	[-]	1,25							
Characteristic resistance CAS 8.8	$V_{Rk,s,C1}$	[kN]	11	17	25	41	64	56	73	90
Partial safety factor	γ_{Ms}	[-]	1,25							
Characteristic resistance CAS 10.9	$V_{Rk,s,C1}$	[kN]	14	22	32	51	80	71	92	112
Partial safety factor	γ_{Ms}	[-]	1,50							
Characteristic resistance CAS A2-70, CAS A4-70	$V_{Rk,s,C1}$	[kN]	10	15	22	36	56	49	64	79
Partial safety factor	γ_{Ms}	[-]	1,56							
Characteristic resistance CAS A4-80	$V_{Rk,s,C1}$	[kN]	11	17	25	41	64	56	73	90
Partial safety factor	γ_{Ms}	[-]	1,33							
Characteristic resistance CAS HCR	$V_{Rk,s,C1}$	[kN]	10	15	22	36	56	49	64	79
Partial safety factor	γ_{Ms}	[-]	1,25							
Characteristic resistance CAS UHCR	$V_{Rk,s,C1}$	[kN]	10	15	22	36	56	49	64	79
Partial safety factor	γ_{Ms}	[-]	1,56							
Characteristic shear load resistance $V_{Rk,s,eq}$ in the Table C7 shall be multiplied by following reduction factor for hot-dip galvanized commercial standard rods										
Reduction factor for hot-dip galvanized rods	$\alpha_{v,h-dg,c1}$	[-]	0,47	0,47	0,47	0,54	0,54	0,88	0,88	0,88
Factor for annular gap	α_{gap}	[-]	0,5							

The anchor shall be used with minimum rupture elongation after fracture $A_5 \geq 9\%$.

ICFS CM 385 PE PRO, ICFS CM 585 PE PRO

Performances

Hammer drilling, Dustless drilling
Seismic performance category C1 of threaded rod

Annex C 9

Table C14: Seismic performance category C1 of rebar - Hammer drilling, Dustless drilling

Size			Ø10	Ø12	Ø16	Ø20	Ø25	Ø32
Tension load								
Steel failure								
Rebar BSt 500 S	$N_{Rk,s,C1}$	[kN]	43	62	111	173	270	442
Partial safety factor	γ_{Ms}	[-]	1,4					
Combined pullout and concrete cone failure in concrete C20/25 for a working life of 50 years and 100 years								
Characteristic bond resistance								
Dry and wet concrete, Flooded hole	$\tau_{Rk,p,C1}$	[N/mm ²]	8,9	9,0	9,0	8,0	7,5	4,8
Installation safety factor								
Hammer drilling - Dry, wet concrete	γ_{inst}	[-]	1,0					
Dustless drilling - Dry, wet concrete	γ_{inst}	[-]	1,2					
Flooded hole	γ_{inst}	[-]	1,2					
Shear load								
Steel failure without lever arm								
Rebar BSt 500 S	$V_{Rk,s,C1}$	[kN]	16	23	41	69	67	111
Partial safety factor	γ_{Ms}	[-]	1,5					
Factor for annular gap	α_{gap}	[-]	0,5					

ICFS CM 385 PE PRO, ICFS CM 585 PE PRO

Performances
 Hammer drilling, Dustless drilling
 Seismic performance category C1 of rebar

Annex C 10

Table C15: Seismic performance category C2 of threaded rod - Hammer drilling, Dustless drilling

Size			M12	M16	M20
Tension load					
Steel failure					
Characteristic resistance CAS 4.6	$N_{Rk,s,C2}$	[kN]	34	63	98
Partial safety factor	γ_{Ms}	[-]	2,00		
Characteristic resistance CAS 5.8	$N_{Rk,s,C2}$	[kN]	42	79	123
Partial safety factor	γ_{Ms}	[-]	1,50		
Characteristic resistance CAS 8.8	$N_{Rk,s,C2}$	[kN]	67	126	196
Partial safety factor	γ_{Ms}	[-]	1,50		
Characteristic resistance CAS 10.9	$N_{Rk,s,C2}$	[kN]	84	157	245
Partial safety factor	γ_{Ms}	[-]	1,33		
Characteristic resistance CAS A2-70, CAS A4-70	$N_{Rk,s,C2}$	[kN]	59	110	172
Partial safety factor	γ_{Ms}	[-]	1,87		
Characteristic resistance CAS A4-80	$N_{Rk,s,C2}$	[kN]	67	126	196
Partial safety factor	γ_{Ms}	[-]	1,60		
Characteristic resistance CAS HCR	$N_{Rk,s,C2}$	[kN]	59	110	172
Partial safety factor	γ_{Ms}	[-]	1,50		
Characteristic resistance CAS UHCR	$N_{Rk,s,C2}$	[kN]	59	110	172
Partial safety factor	γ_{Ms}	[-]	1,87		
Combined pullout and concrete cone failure in concrete C20/25 for a working life of 50 years and 100 years					
Characteristic bond resistance					
Dry and wet concrete, Flooded hole	$\tau_{Rk,p,C2}$	[N/mm ²]	3,2	3,7	4,2
Installation safety factor					
Dry and wet concrete, Flooded hole	γ_{inst}	[-]	1,0		
Dustless drilling – Flooded hole	γ_{inst}	[-]	1,2		
Shear load					
Steel failure without lever arm					
Characteristic resistance CAS 4.6	$V_{Rk,s,C2}$	[kN]	13	18	28
Partial safety factor	γ_{Ms}	[-]	1,67		
Characteristic resistance CAS 5.8	$V_{Rk,s,C2}$	[kN]	16	22	35
Partial safety factor	γ_{Ms}	[-]	1,25		
Characteristic resistance CAS 8.8	$V_{Rk,s,C2}$	[kN]	25	36	56
Partial safety factor	γ_{Ms}	[-]	1,25		
Characteristic resistance CAS 10.9	$V_{Rk,s,C2}$	[kN]	32	45	70
Partial safety factor	γ_{Ms}	[-]	1,50		
Characteristic resistance CAS A2-70, CAS A4-70	$V_{Rk,s,C2}$	[kN]	22	31	49
Partial safety factor	γ_{Ms}	[-]	1,56		
Characteristic resistance CAS A4-80	$V_{Rk,s,C2}$	[kN]	25	36	56
Partial safety factor	γ_{Ms}	[-]	1,33		
Characteristic resistance CAS HCR	$V_{Rk,s,C2}$	[kN]	22	31	49
Partial safety factor	γ_{Ms}	[-]	1,25		
Characteristic resistance CAS UHCR	$V_{Rk,s,C2}$	[kN]	22	31	49
Partial safety factor	γ_{Ms}	[-]	1,56		
Characteristic shear load resistance $V_{Rk,s,eq}$ in the Table C9 shall be multiplied by following reduction factor for hot-dip galvanized commercial standard rods					
Reduction factor for hot-dip galvanized rods	$\alpha_{v,h-dg,c2}$	[-]	0,46	0,61	0,61
Factor for annular gap	α_{gap}	[-]	0,5		

Table C16: Displacement under tensile and shear load - seismic category C2 of threaded rod

Size		M12	M16	M20
$\delta_{N,eq}(DLS)$	[mm]	0,20	0,40	0,77
$\delta_{N,eq}(ULS)$	[mm]	0,76	0,74	1,68
$\delta_{V,eq}(DLS)$	[mm]	5,29	4,12	4,94
$\delta_{V,eq}(ULS)$	[mm]	10,20	9,05	10,99

The anchor shall be used with minimum rupture elongation after fracture $A_5 \geq 9\%$.

ICFS CM 385 PE PRO, ICFS CM 585 PE PRO

Performances

Hammer drilling, Dustless drilling
Seismic performance category C2 of threaded rod

Annex C 11